

Thank you for selecting this YAMAHA NS-M515 speaker system.

PRECAUTIONS

Read this before using the speaker.

- To assure the finest performance, please read this manual carefully. Keep it in a safe place for future reference.
- Install the speaker in a cool, dry, clean place – away from windows, heat sources, sources of excessive vibration, dust, moisture and cold. Avoid sources of humming (transformers, motors). To prevent fire or electrical shock, do not expose the speaker to rain or water.
- To prevent the enclosure from warping or discoloring, do not place the speaker where it will be exposed to direct sunlight or excessive humidity.
- Do not place the following objects on the speaker:
 - Glass, china, etc.
If glass etc. falls by vibrations and breaks, it may cause personal injury.
 - A burning candle etc.
If the candle falls by vibrations, it may cause fire and personal injury.
 - A vessel with water in it
If the vessel falls by vibrations and water spills, it may cause damage to the speaker, and/or you may get an electric shock.
- Do not place the speaker where foreign objects such as water drips might fall. It might cause a fire, damage to the speaker, and/or personal injury.
- Do not place the speaker where it is liable to be knocked over or struck by falling objects. Stable placement will also ensure better sound performance.
- Placing the speaker on the same shelf or rack as the turntable can result in feedback.
- Never put a hand or a foreign object into the port located on the rear of the speaker as this might cause personal injury and/or damage to the speaker.
- When moving the speaker, do not hold the port as it might cause personal injury and/or damage to the speaker.
- Any time you note distortion, reduce the volume control on your amplifier to a lower setting. Never allow your amplifier to be driven into "clipping". Otherwise the speaker may be damaged.
- When using an amplifier with a rated output power higher than the nominal input power of the speaker, care should be taken never to exceed the speaker's maximum input.
- Do not attempt to clean the speaker with chemical solvents as this might damage the finish. Use a clean, dry cloth.
- Do not attempt to modify or fix the speaker. Contact qualified YAMAHA service personnel when any service is needed. The cabinet should never be opened for any reasons.
- **Secure placement or installation is the owner's responsibility.**
YAMAHA shall not be liable for any accident caused by improper placement or installation of the speaker.

PLACING THE SPEAKERS

Place the speakers on a sturdy, vibration-free surface, on a well-built stand.

■ Using as 2ch stereo speakers

Better stereo images will be obtained when the speakers are slightly angled in towards the listeners.

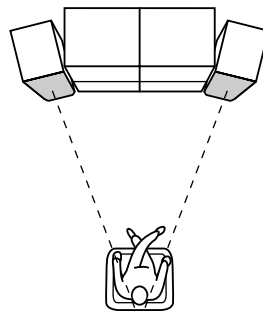

■ Using as main speakers in a multi channel system

Position the speakers on both sides of the TV. The positioning of speakers is important, because it controls the whole sound quality of a multi channel system. Set up the speakers on the basis of your listening position by following the owner's manual supplied with your amplifier.

■ Using as front effect or effect speakers

Mount the speakers on a wall or place the speakers on a shelf. Determine the best position by following the owner's manual supplied with your amplifier.

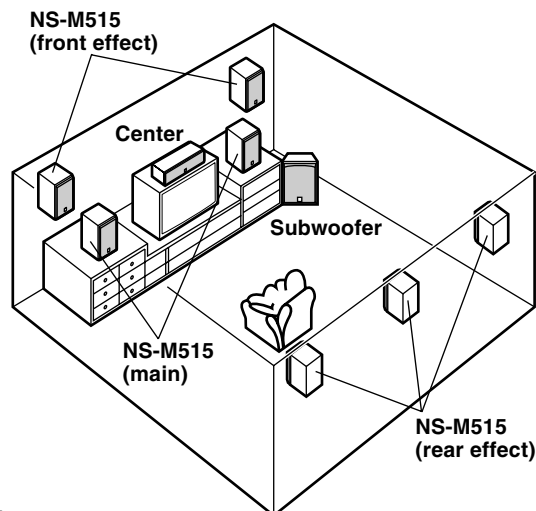

Note

This speaker features a magnetically shielded design, but there is still a chance that placing it too close to a TV set might impair picture color. Should this happen, move the speaker away from the TV set.

■ To mount the speaker on a wall by using the attached mounting bracket

Fasten screws into a firm wall or wall support as shown in the figure, and hang the holes of the mounting bracket on the protruding screws.

* Make sure that the screws are securely caught by the narrow parts of the holes.

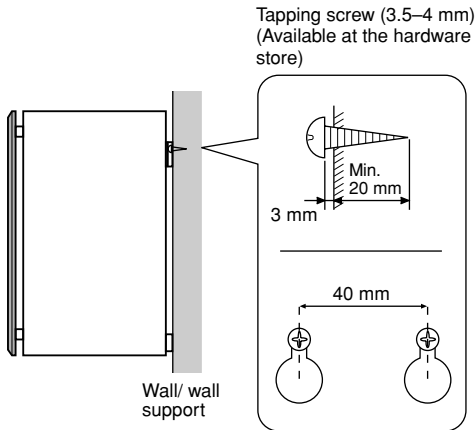

You can also use the screw holes on the rear of the speaker for installing the speaker using a commercially available speaker bracket (if you do not use the attached mounting bracket).

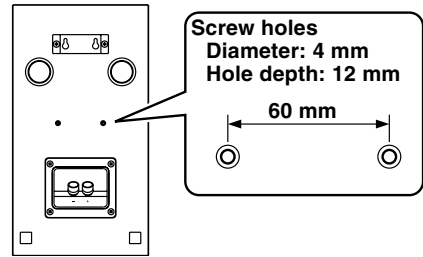

WARNING

- This speaker weighs 5.0 kg (11 lbs.). Do not mount it on thin plywood or a wall with soft surface material. If mounted, the screws may come out of the flimsy surface and the speaker may fall. This damages the speaker or causes personal injury.
- Do not install the speaker to a wall with nails, adhesives, or any other unstable hardware. Long-term use and vibrations may cause it to fall.
- To avoid accidents resulting from tripping over loose speaker cable, fix it to the wall.

CONNECTIONS TO YOUR AMPLIFIER

Before making connections, make sure that the amplifier is switched off.

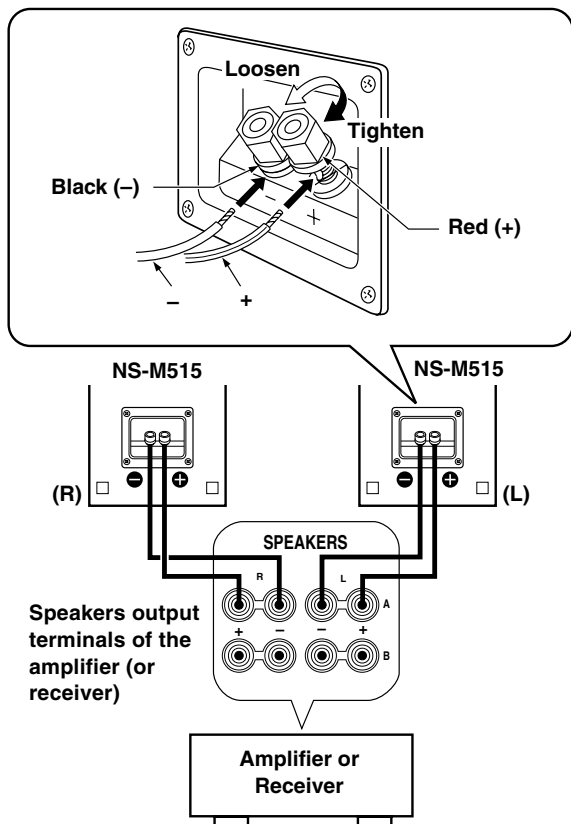

■ CONNECTIONS

- Connect the screw-type input terminals at the rear of the speakers to the speaker output terminals of the amplifier (or receiver) with the speaker cable.
- Connect the (+) terminals on the amplifier (or receiver) and the speakers using one side of the cable. Connect the (-) terminals on both components using the other side of the cable.
- Connect one speaker to the left (marked L) terminals of your amplifier, and another speaker to the right (marked R) terminals, making sure not to reverse the polarity (+, -). If one speaker is connected with reversed polarity, the sound will be unnatural and lack bass.

How to connect:

- ① Loosen the knob.
- ② Remove the insulation coating at the extremity of each speaker cable by twisting the coating off.

Good **No Good**



- ③ Insert the bare wire.
- ④ Tighten the knob and secure the cables.
Test the firmness of the connection by pulling lightly on the cables at the terminal.

Note

Do not let the bare speaker wires touch each other as this could damage the speaker or the amplifier, or both of them.

When using a banana plug

<General model only>

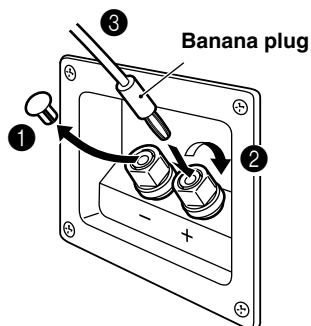

- ① Remove the cover by pulling it toward you.
- ② Tighten the terminal knob.
- ③ Simply insert the banana plug into the terminal.

REMOVING THE FRONT COVER

The front cover is fastened to the enclosure at four points and can be removed if desired. To remove the cover, hold on to both sides and slowly pull straight away from the speaker. To reattach, line up the four holes on the inner surface of the cover with the four corresponding pegs on the speaker and push gently.

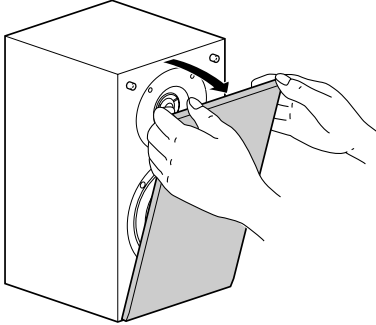

Note

When the cover is removed, take care not to touch the speaker units with your hands or to exert excessive force with tools.

SPECIFICATIONS

Type	2-way bass reflex speaker system Magnetic shielding type
Driver	13 cm (5") cone woofer 3 cm (1") dome tweeter
Impedance	6 Ω
Frequency Response	60 Hz to 50 kHz
Nominal Input Power	60 W
Maximum Input Power	200 W
Sensitivity	89 dB/2.83 V/m
Crossover Frequency	3kHz
Dimensions (WxHxD)	180 x 333 x 184 mm (7-1/16" x 13-1/8" x 7-1/4")
Weight	5.0 kg (11 lbs.)

- Specifications are subject to change without notice due to product improvements.
- Care should be taken not to exceed the input power values noted above.



YAMAHA ELECTRONICS CORPORATION, USA 6660 ORANGETHORPE AVE., BUENA PARK, CALIF. 90620, U.S.A.
YAMAHA CANADA MUSIC LTD. 135 MILNER AVE., SCARBOROUGH, ONTARIO M1S 3R1, CANADA
YAMAHA ELECTRONIK EUROPA G.m.b.H. SIEMENSSTR. 22-34, 25462 RELLINGEN, BEI HAMBURG, F.R. OF GERMANY
YAMAHA ELECTRONIQUE FRANCE S.A. RUE AMBROISE CROIZAT BP70 CROISSY-BEAUBOURG 77312 MARNE-LA-VALLÉE CEDEX02, FRANCE
YAMAHA ELECTRONICS (UK) LTD. YAMAHA HOUSE, 200 RICKMANSWORTH ROAD WATFORD, HERTS WD1 7JS, ENGLAND
YAMAHA SCANDINAVIA A.B. J A WETTERGRENS GATA 1, BOX 30053, 400 43 VÄSTRA FRÖLUNDA, SWEDEN
YAMAHA MUSIC AUSTRALIA PTY, LTD. 17-33 MARKET ST., SOUTH MELBOURNE, 3205 VIC., AUSTRALIA

YAMAHA CORPORATION

Printed in Indonesia 

V993880